

I

GB

F

D

E

NL

LAVORO

CRISTAL CLEAN *Sprinter* IL LAVASCIUGA

ATTENZIONE: LEGGERE LE ISTRUZIONI PRIMA DELL'USO

:

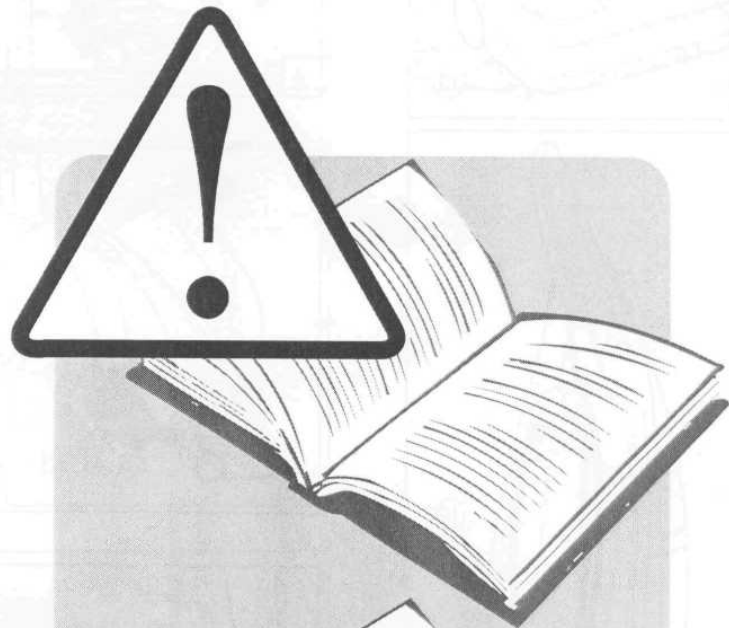

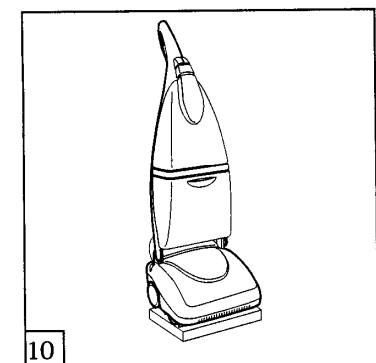
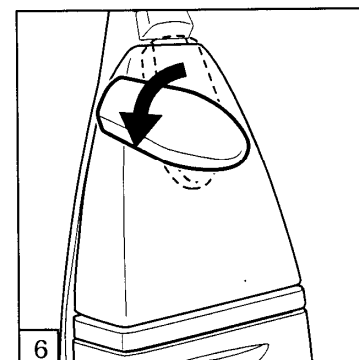
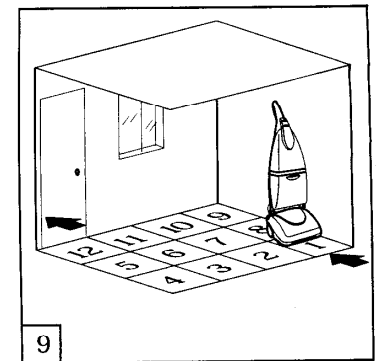
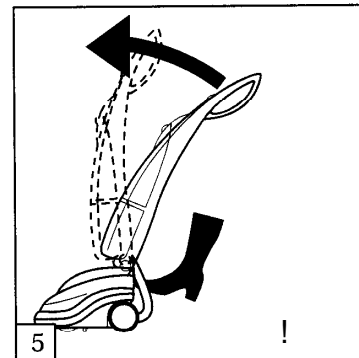
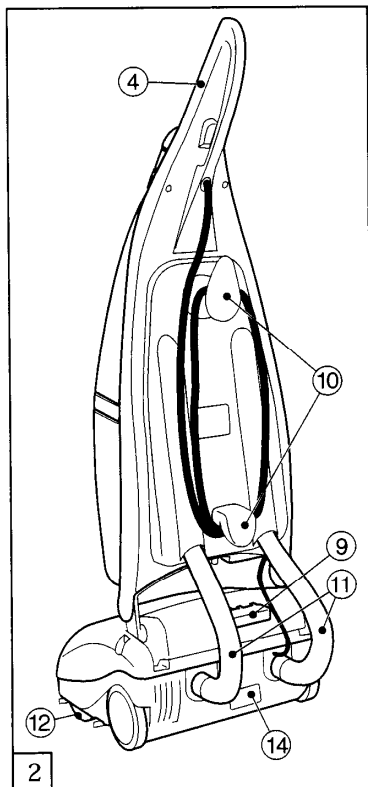
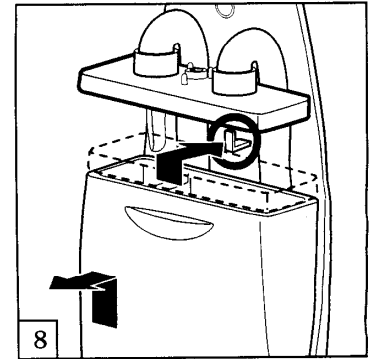
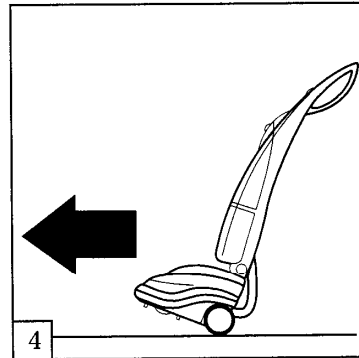
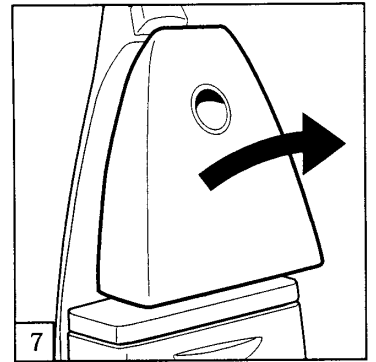
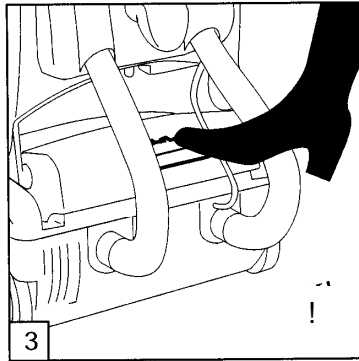
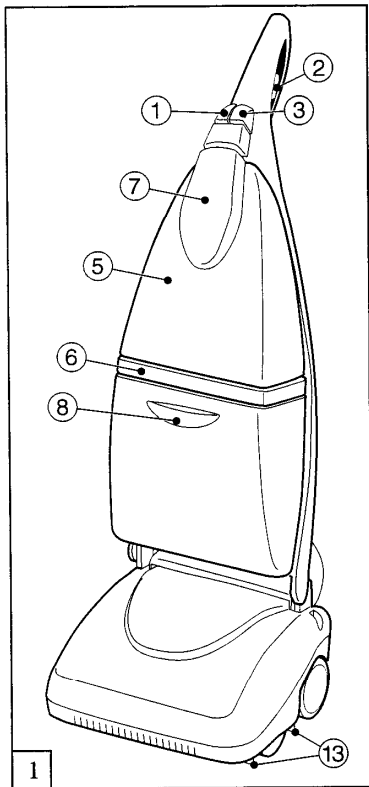

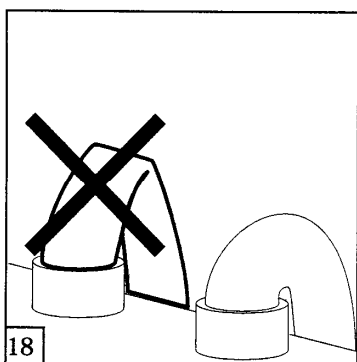
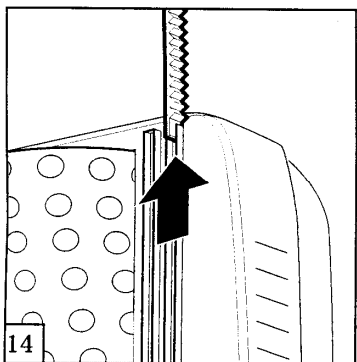
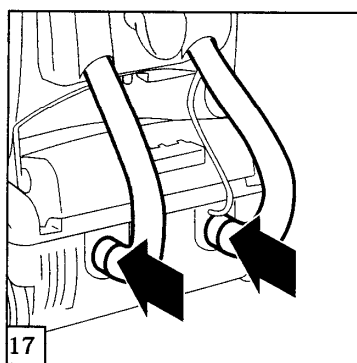
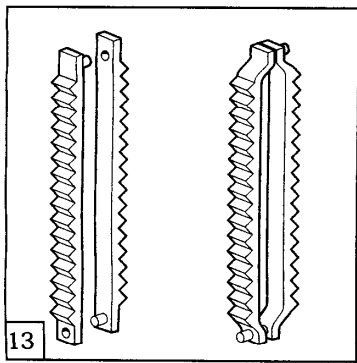
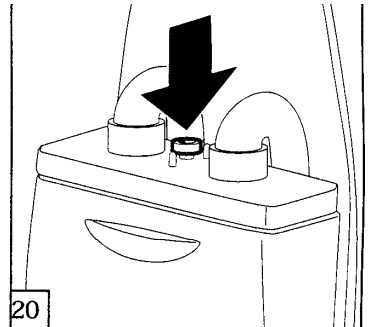
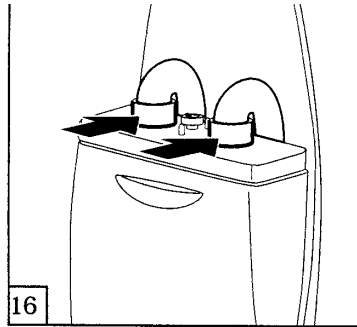
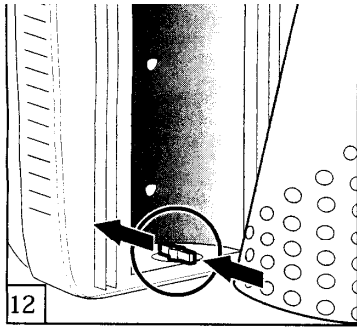
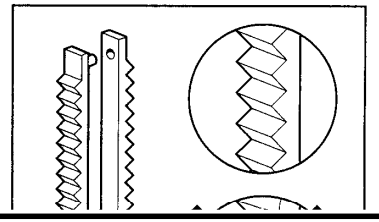
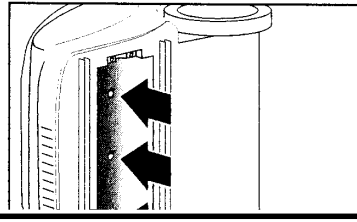
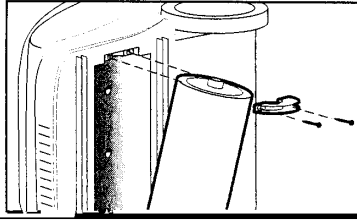

- 1.
- 2.
- 3.
- 4.
- 5.
- 6.
- 7.
- 8.
- 9.
- 10.
- 11.
- 12.
- 13.
- 14.

Sqeegee

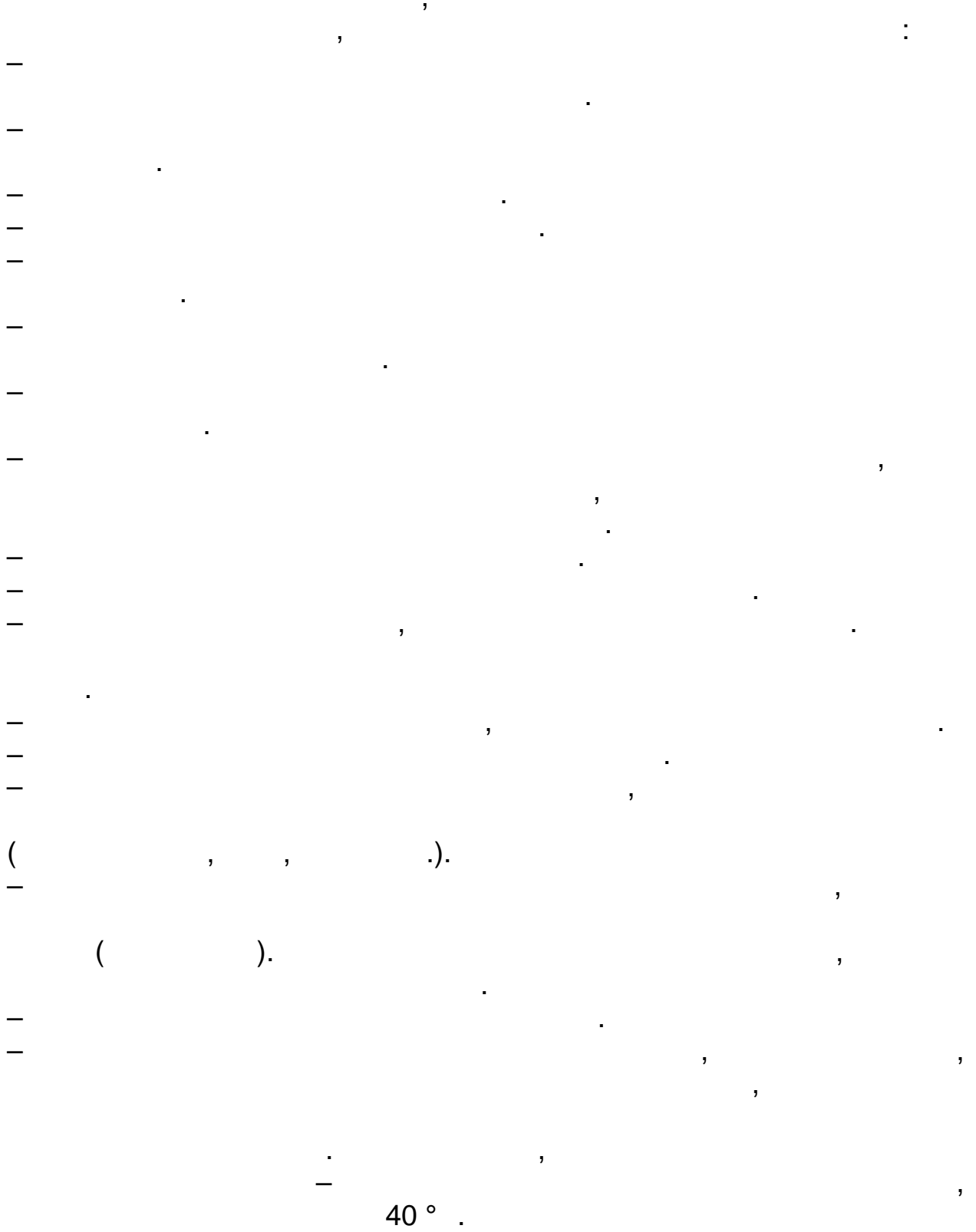



1,0	2 —	. 12,5
1,5	2 —	. 20
2,5	2 —	. 30



, . ,
(')

- 9 (. 2).

(. 3).

squeegie (. 4).

(. 5).

3 (. 1)

- 1.
- 2.
- 3.

5 (. 1)

2,8

1

(. 6)

(. 7)

6 (. 1)

squeegie,

(. 8).

(. 18).

8 (. 1)

(. 8).

(. 2).

— 1 (. 1),
— 2 (. 1),
— ,
— 3 (. 1),
— . 9.
— .
— ,
— ,
— .
— .
— sqeegee .
— , (.
2) .
— ,
— .
— , , ,
— . sqeegee (. 10).
— 2 , . 11,.
— ,
— ,
— .
— , ,

) (. 13). (.
 - , -
 - (. 18). (. 16 17)
 - sqeegee (. 19).
 «
 ».
 ,
 .
 ,
 (. 15) 4 ,
 ,
 .
 ,
 (. 8).
 ,
 .

— , .

— , .

— :

— (, ,

— , ,

—);

— ;

— , .

— ;

— ;

— / .

— :

— , (, squeegee,

—).

— , ,

— .

— .

LAVOR
via J.F. Kennedy, 12
46020 PEGOGNAGA (MN)

⋮
FLOOR SCRUBBER DRIER (-)
⋮
Sprinter il lavasciuga

89/392/CEE , 73/23/CEE, 89/336/CEE.

Pegognaga, 05/01/2001
Giancarlo Lanfredi –